

SAGINAW CONTROL & ENGINEERING SCE-726024ULP

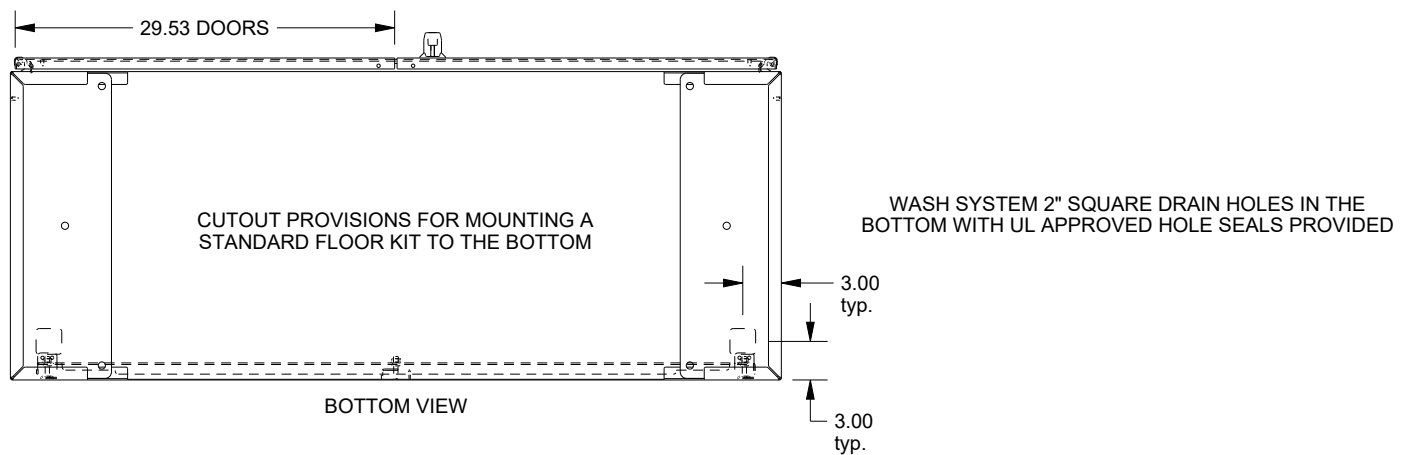

WASH SYSTEM 2" SQUARE DRAIN HOLES IN THE BOTTOM WITH UL APPROVED HOLE SEALS PROVIDED

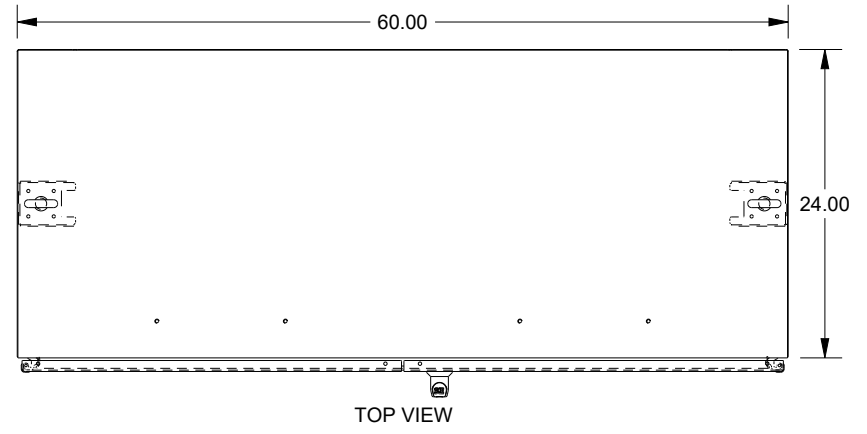